

## SPECIFICATION FOR CERAMIC COB LED

**Part No:** LCOB35-25W030XXER80-0640

**Description:**

28\*28mm COB LED

**Dice Material:** InGaN

**Confirmed by Customer:** \_\_\_\_\_

**Approved by**

**Checked by**

**Prepared by**

\_\_\_\_\_

\_\_\_\_\_

\_\_\_\_\_

罗顺达



## LCOB35-25W030XXER80

### BS-High CRI Series COB LED



### Introduction

Lightspot BS High CRI series LED Light engine is based on our main patent----- **MCOB** ( **M**ulti-**C**hips **O**n **B**oard ) . Lightspot LEDs combine tens or hundreds power LED chips with a rugged package capable of operating in excess of power . Lightspot LEDs maximumly decrease LED uncomfortable glare and also Zebra strips, at the same time increase LED light efficiency and reduce thermal resistance.

### Features:

- ◇ Area light source, which can avoid glare
- ◇ More energy efficient than incandescent , halogen and some fluorescent lamps
- ◇ Industry's lowest thermal resistance
- ◇ Long operating life, lumen maintenance of greater than 70% after 50,000 hours
- ◇ Low forward voltage operated
- ◇ Instant light (less than 100ns)
- ◇ Lead Free product, RoHS compliant
- ◇ No UV

### Application

- ◇ Automotive interior / exterior lighting
- ◇ Automotive signal lighting
- ◇ General Torch
- ◇ Architectural lighting
- ◇ LCD TV / Monitor Backlight
- ◇ Projector light source
- ◇ Traffic signals
- ◇ Task lighting
- ◇ Decorative / Pathway lighting
- ◇ Remote / Solar powered lighting
- ◇ Household appliances

## Outline Dimensions:

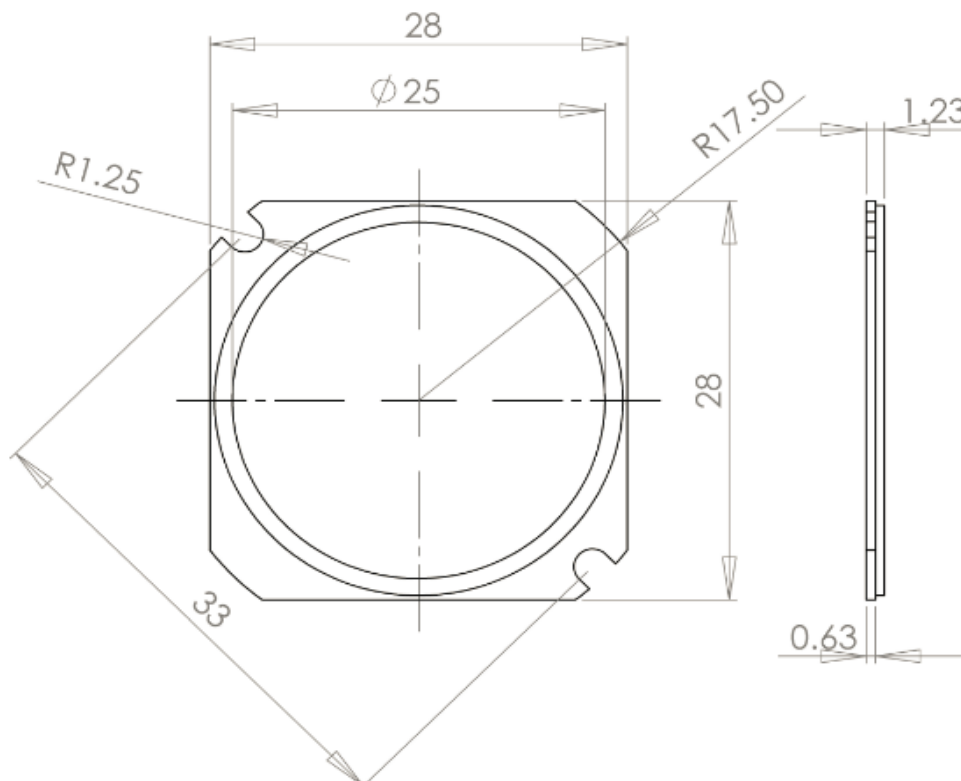

**LCOB35-25W030XXER80**

## Absolute Maximum Ratings at $T_a=25^\circ\text{C}$ :

| Parameter  | Part No.                  | Symbol         | Maximum          | Unit |
|--|---------------------------|----------------|------------------|------|
| Power Dissipation  | LCOB35-25W030XXER80       | Pd             | 25               | W    |
| Peak Forward Current<br>(1/10 Duty Cycle, 0.1ms Pulse Width) |                           | IF(peak)       | 800              | mA   |
| Continuous Forward Current                                   |                           | IF             | 640              | mA   |
| LED junction temperature                                     |                           | JT             | 120              | °C   |
| Reverse Voltage  |                           | VR             | 60               | V    |
| Thermal Resistance, junction to case                         | LCOB35-25W030XXER80       | R $\theta$ j-c | 2.5              | °C/W |
| Soldering Temperature °C                                     | 5 seconds, 260°C or lower |                |                  |      |
| Operating temperature range                                  |                           | Topr           | -30°C to + 85°C  |      |
| Storage Temperature Range                                    |                           | Tstg           | -40°C to + 100°C |      |

● Warm white

| Parameter             | Part No.            | Symbol         | Test Condition        | Min. | Typ. | Max. | Unit |
|-----------------------|---------------------|----------------|-----------------------|------|------|------|------|
| Luminous flux         | LCOB35-25W030XXER80 | $\phi$         | I <sub>F</sub> =640mA | 1750 | /    | 2300 | lm   |
| Viewing Angle         |                     | 2 $\theta$ 1/2 |                       |      | 140  |      | deg  |
| Forward Voltage       |                     | V <sub>F</sub> | I <sub>F</sub> =640mA | 36   | /    | 44   | V    |
| Reverse Current       |                     | I <sub>R</sub> | V <sub>R</sub> =60V   |      |      | 100  | uA   |
| Correspondingly       |                     | CCT            |                       | 2870 | 3045 | 3220 | K    |
| Color Rendering Index |                     | CRI            |                       | 80   | /    | 85   |      |

- 1、The luminous intensity data did not include  $\pm 10\%$  testing tolerance.
- 2、Tolerance of CRI is  $\pm 2$ .

### Relative Spectral Power Distribution

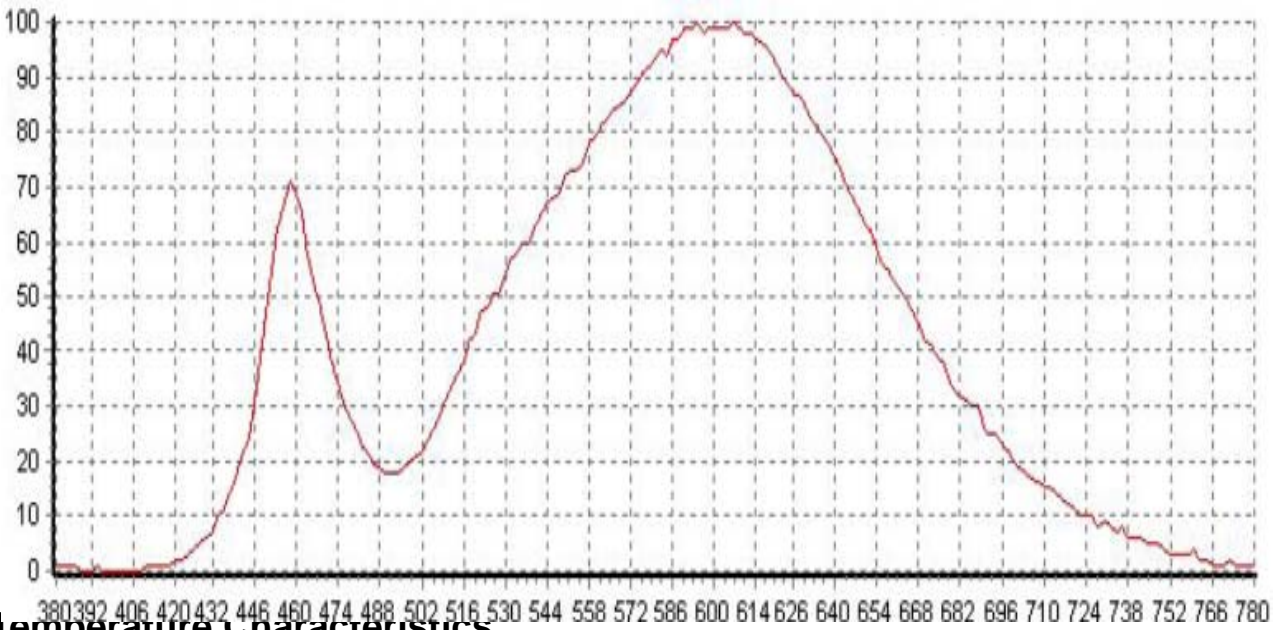

## Temperature Characteristics

Relative Luminous Flux(@640mA) vs.  $T_p$  Temperature

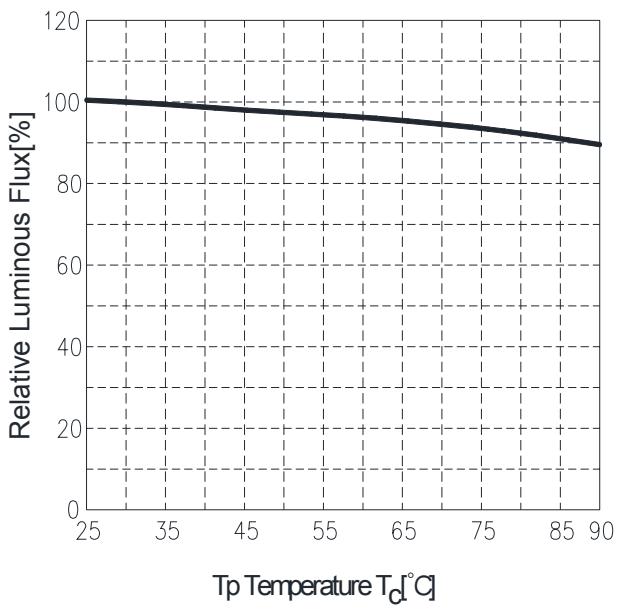

Forward Voltage (@640mA) vs.  $T_p$  Temperature

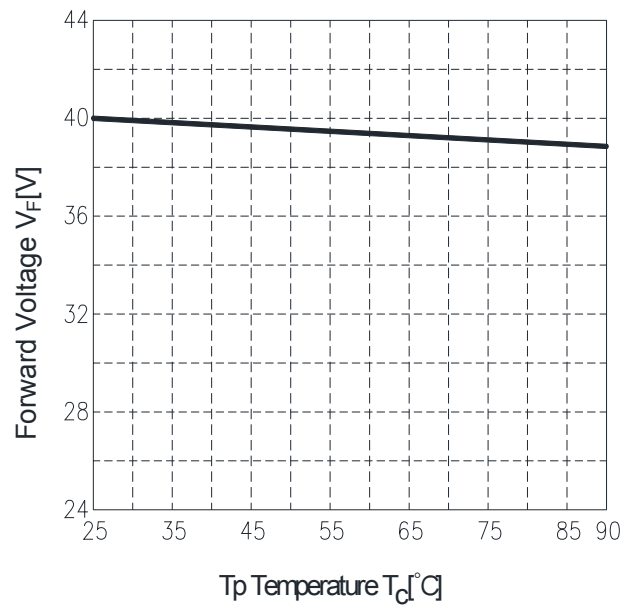

(measuring point for  $T_p$  Temperature)

Please ensure the maintenance of heat radiation not to exceed  $T_p$  temperature over the rating in operation.

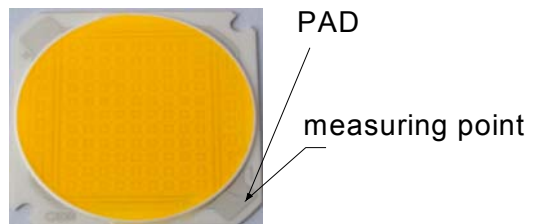

## Electrical Characteristics

Relative Luminous Flux( $T_c=25^\circ\text{C}$ ) vs. Forward Current

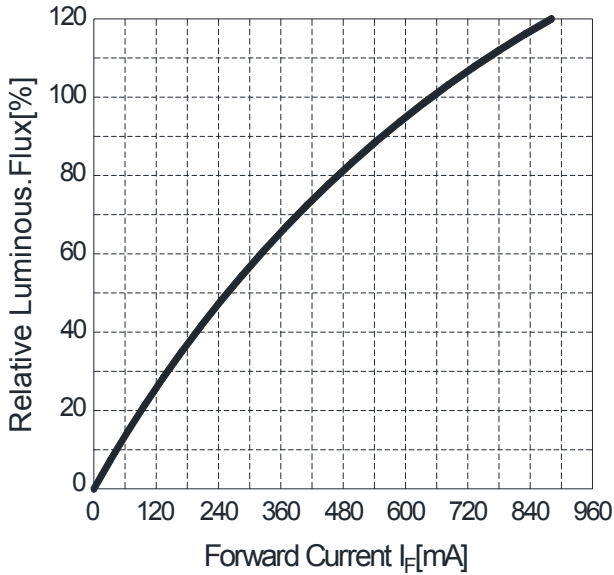

Forward Current( $T_c=25^\circ\text{C}$ ) vs. Forward Voltage

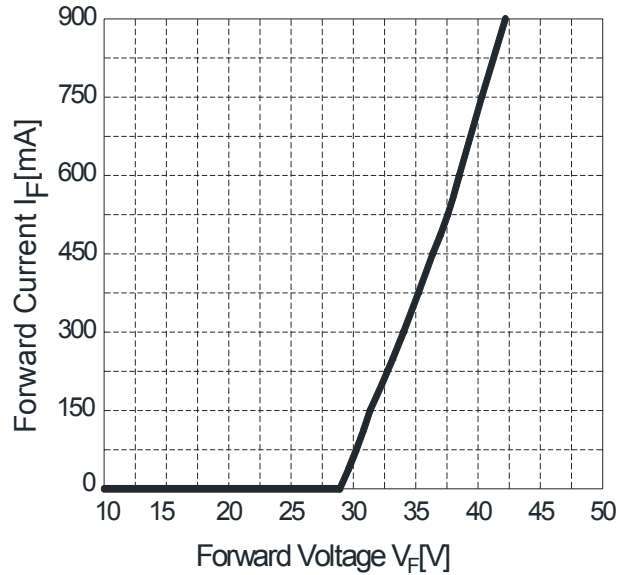

## Derating Curves characteristics

### Forward Current Derating Curve

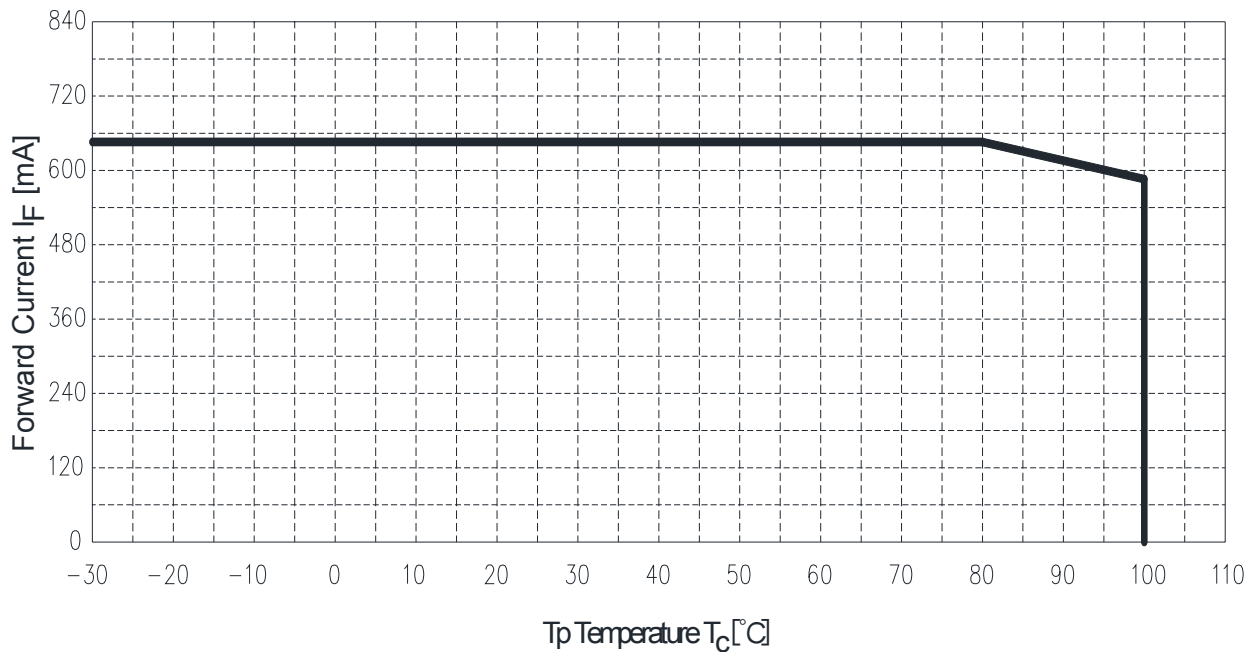

To keep  $T_p$ (PAD-temperature) lower than rating enough heat-radiation performance needs to be secured by using an adequate heat sink.

## Typical Polar Radiation Pattern

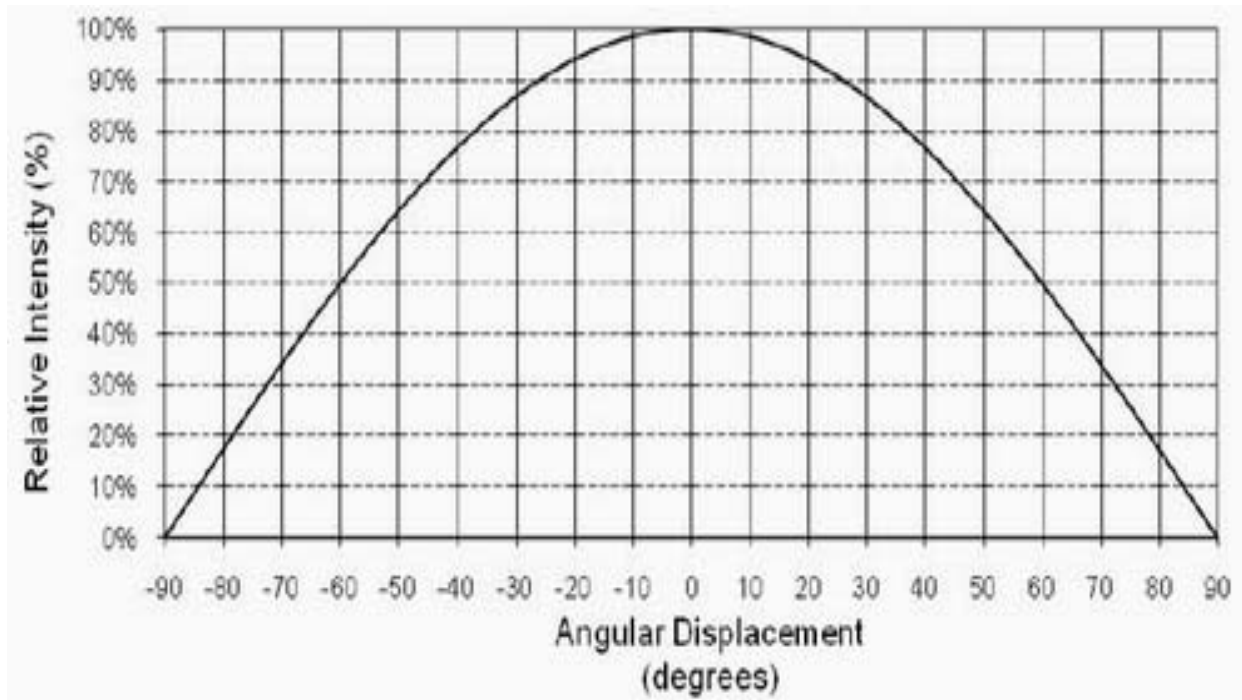

## Typical Spatial Radiation Pattern

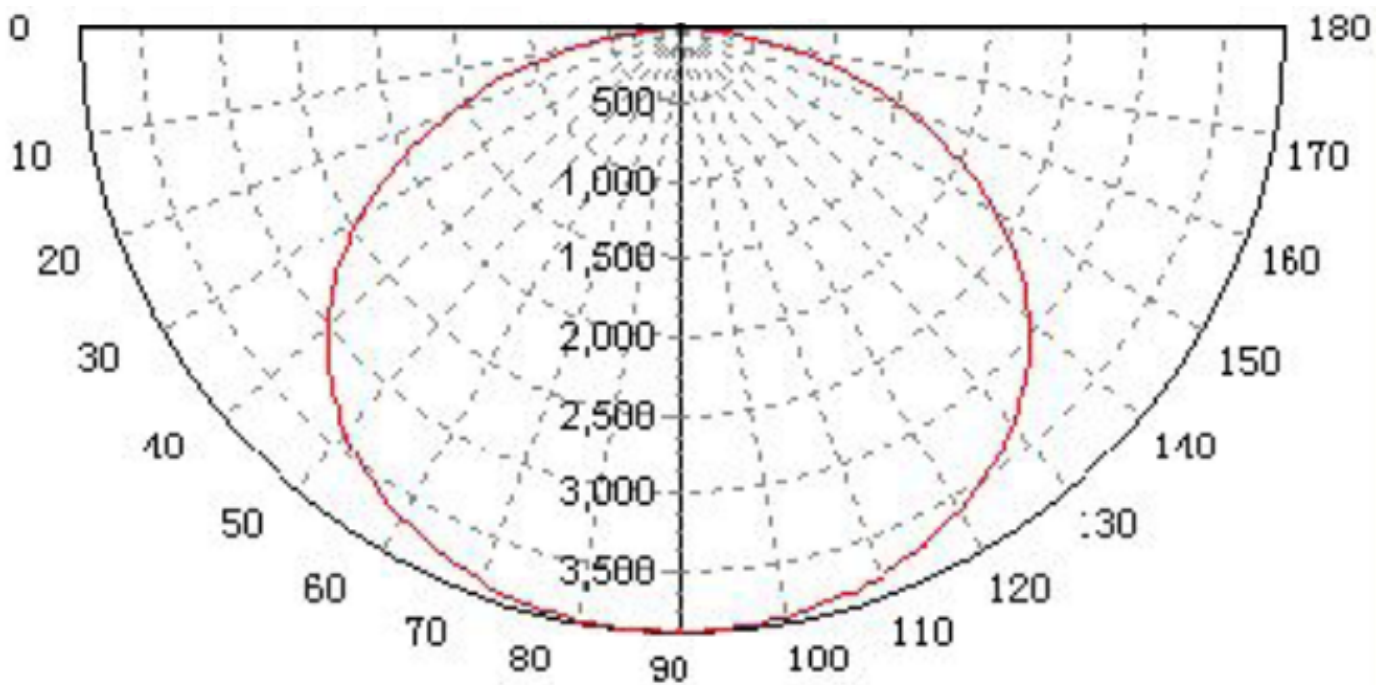

## Typical Polar Radiation Pattern

## Order Code

**LC OB35-10W0 30 XX E R80 0400**  
X1            X2                    X3            X4    X5    X6    X7            X8

### Part Number System:

X1: "LC" Abbr."Lightspot Ceramic COB"

X2: COB LED Outline Size: 4008、4012、6012; OB25、OB35、OB50

X3: Power. 10W0 repents 10Watt

X4: Color temperature: 27、30、35、40、45、50、57、65...

X5: Chip specification

X6: Lumen range, 如:  $70\text{lm/w} \leq E < 90\text{lm/w}$ ;  $90\text{lm/w} \leq F < 110\text{lm/w}$ ;

$110\text{lm/w} \leq G < 130\text{lm/w}$

X7: Color rendering Index(CRI):  $55 \leq R55 < 60$ ;  $60 \leq R60 < 65$ ;  $65 \leq R65 < 70$ ;  $70 \leq R70 < 75$

$75 \leq R75 < 80$ ;  $80 \leq R80 < 85$ ;  $85 \leq R85 < 90$ ;  $90 \leq R90 < 95$

H: Standard Forward Current. 0400 repents 400mA

### NOTICE:

- All dimensions are in millimeter.
- Tolerance is  $\pm 0.1\text{mm}$  unless otherwise noted.
- It is strongly recommended that the temperature of lead be not higher than  $60^\circ\text{C}$ .
- This information in this document is subject to change in order to improve reliability, design or function without prior notice and does not represent a commitment on the part of this company.
- Avoids preserving in the high temperature, the high-moisture, as well as in the acidic environment .