

# SPECIFICATION FOR CERAMIC COB LED

**Part No:** LCOB35-07W565XXER80-0200

**Description:**

28\*28mm COB LED

**Dice Material:** InGaN

**Confirmed by Customer:** \_\_\_\_\_

**Approved by**

**Checked by**

**Prepared by**

\_\_\_\_\_

\_\_\_\_\_

\_\_\_\_\_

罗顺达

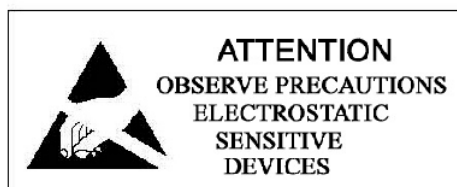

# LCOB35-07W565XXER80

## BS-High CRI Series COB LED



### Introduction

Lightspot BS High CRI series LED Light engine is based on our main patent----- **MCOB** ( **M**ulti-**C**hips **O**n **B**oard ) . Lightspot LEDs combine tens or hundreds power LED chips with a rugged package capable of operating in excess of power . Lightspot LEDs maximumly decrease LED uncomfortable glare and also Zebra strips, at the same time increase LED light efficiency and reduce thermal resistance.

### Features:

- ◇ Area light source, which can avoid glare
- ◇ More energy efficient than incandescent , halogen and some fluorescent lamps
- ◇ Industry's lowest thermal resistance
- ◇ Long operating life, lumen maintenance of greater than 70% after 50,000 hours
- ◇ Low forward voltage operated
- ◇ Instant light (less than 100ns)
- ◇ Lead Free product, RoHS compliant
- ◇ No UV

### Application

- ◇ Automotive interior / exterior lighting

- ◇ Automotive signal lighting
- ◇ General Torch
- ◇ Architectural lighting
- ◇ LCD TV / Monitor Backlight
- ◇ Projector light source
- ◇ Traffic signals
- ◇ Task lighting
- ◇ Decorative / Pathway lighting
- ◇ Remote / Solar powered lighting
- ◇ Household appliances

## Outline Dimensions:

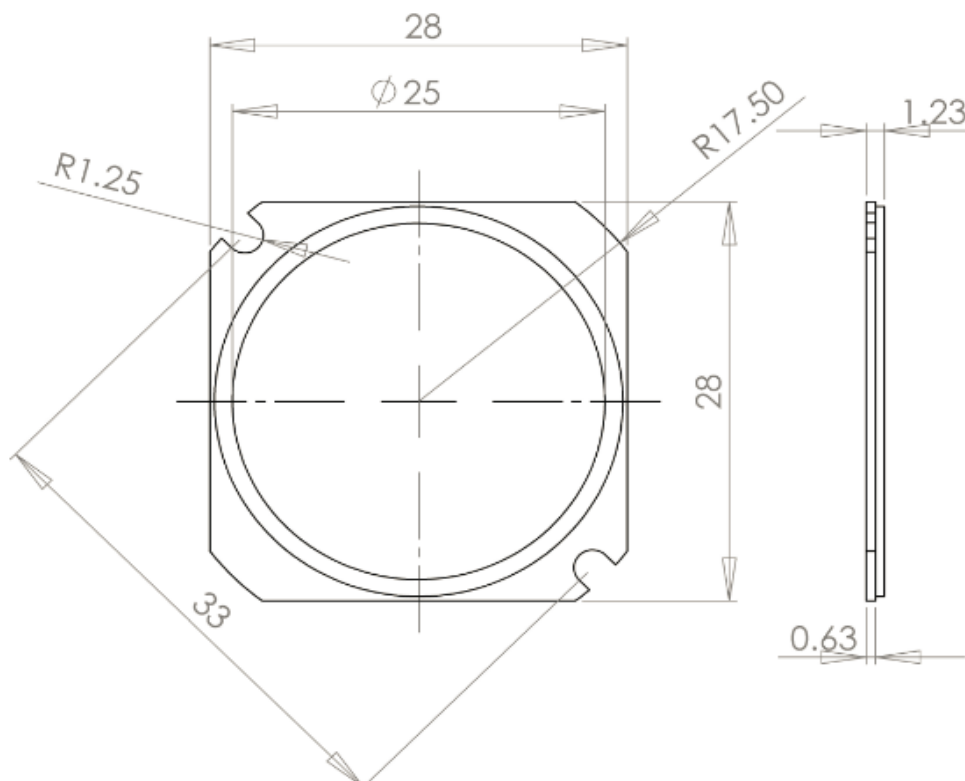

**LCOB35-07W565XXER80**

## Absolute Maximum Ratings at $T_a=25^{\circ}\text{C}$ :

Parameter	Part No.	Symbol	Maximum	Unit
Power Dissipation	LCOB35-07W565XXER80	Pd	7.5	W
Peak Forward Current (1/10 Duty Cycle, 0.1ms Pulse Width)		IF(peak)	300	mA
Continuous Forward Current		IF	200	mA
LED junction temperature		JT	120	°C
Reverse Voltage		VR	60	V
Thermal Resistance, junction to case	LCOB35-07W565XXER80	R $\theta$ j-c	2.0	°C/W
Soldering Temperature °C	5 seconds, 260°C or lower			
Operating temperature range		Topr	-30°C to + 85°C	
Storage Temperature Range		Tstg	-40°C to + 100°C	

● Cool white

Parameter	Part No.	Symbol	Test Condition	Min.	Typ.	Max.	Unit
Luminous flux	LCOB35-07W565XXER80	$\phi$	I <sub>F</sub> =200mA	530	/	700	lm
Viewing Angle		2 $\theta$ 1/2			140		deg
Forward Voltage		V <sub>F</sub>	I <sub>F</sub> =200mA	33.6	37.5	40.8	V
Reverse Current		I <sub>R</sub>	V <sub>R</sub> =60V			100	uA
Correspondingly		CCT		6020	6530	7040	K
Color Rendering Index		CRI		80	/	85	

- 1、 The luminous intensity data did not include  $\pm 10\%$  testing tolerance.
- 2、 Tolerance of CRI is  $\pm 2$ .

### Relative Spectral Power Distribution

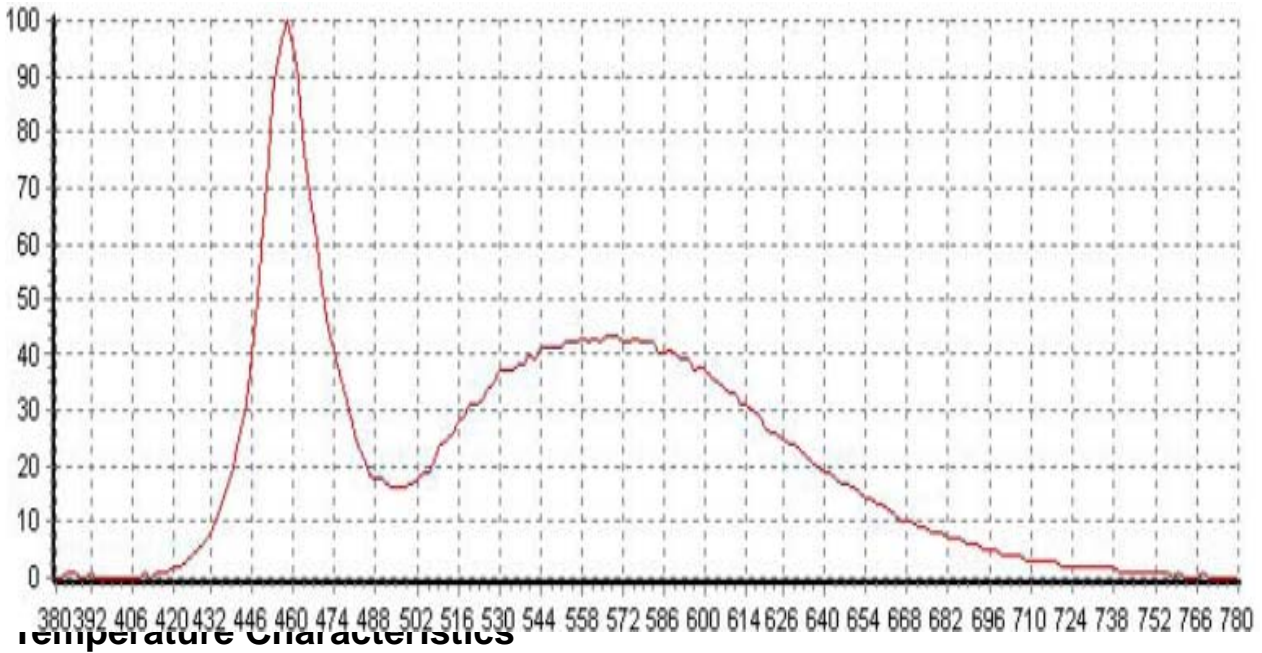

Relative Luminous Flux(@200mA) vs. Tp Teperature

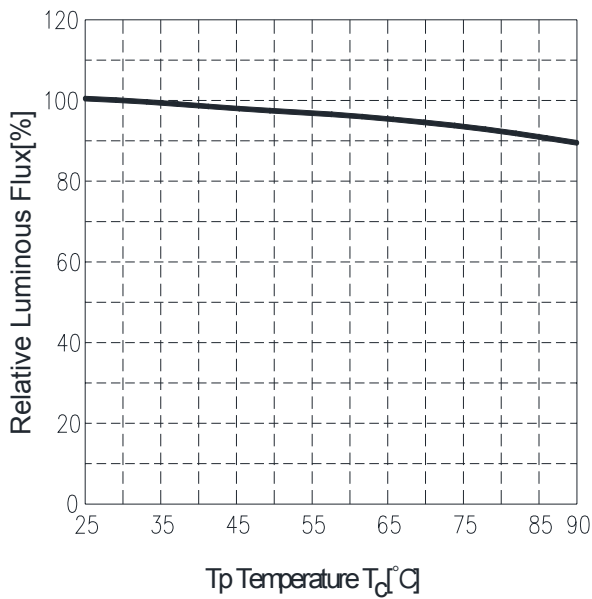

Forward Voltage (@200mA)vs.Tp Temperature

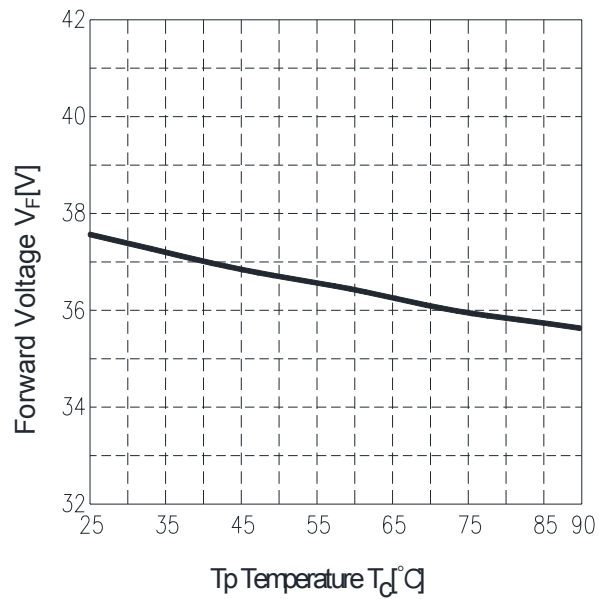

(measuring point for Tp Temperature)

Please ensure the maintenance of heat radiation not to exceed Tp temperature over the rating in operation.

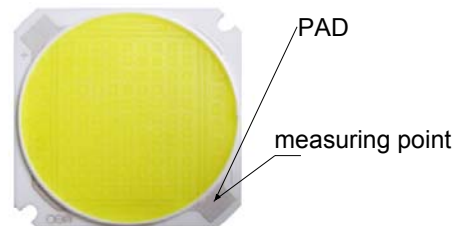

**Electrical Characteristics**

Relative Luminous.Flux( $T_c=25^\circ\text{C}$ ) vs.Forward Current

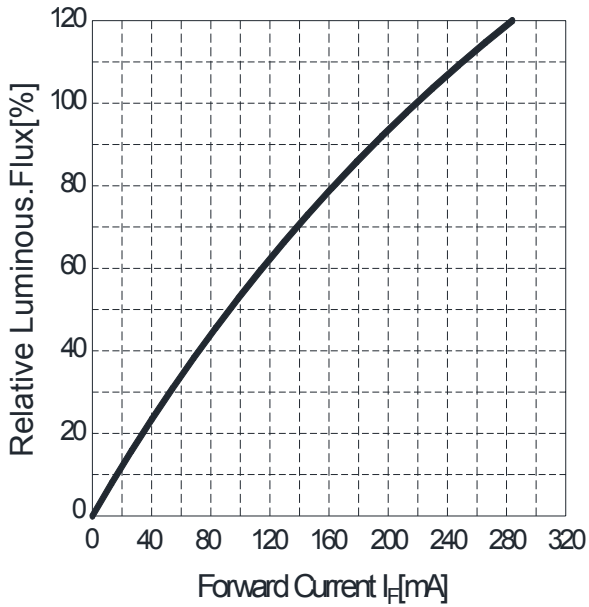

Forward Current( $T_c=25^\circ\text{C}$ ) vs.Forward Voltage

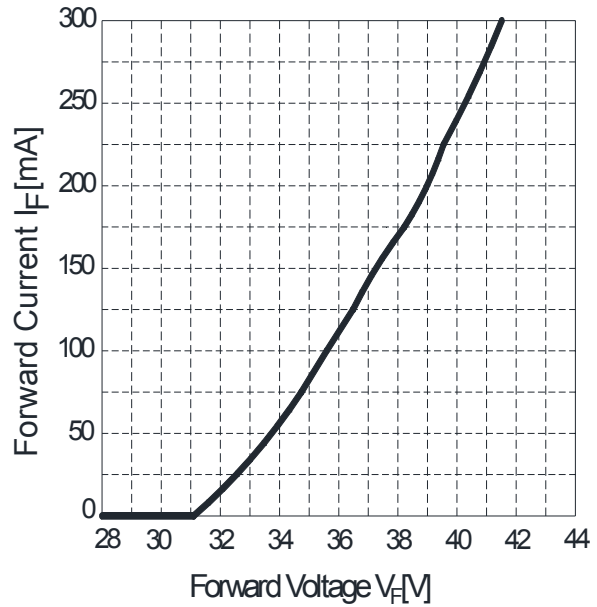

**Derating Curves characteristics**

**Forward Current Derating Curve**

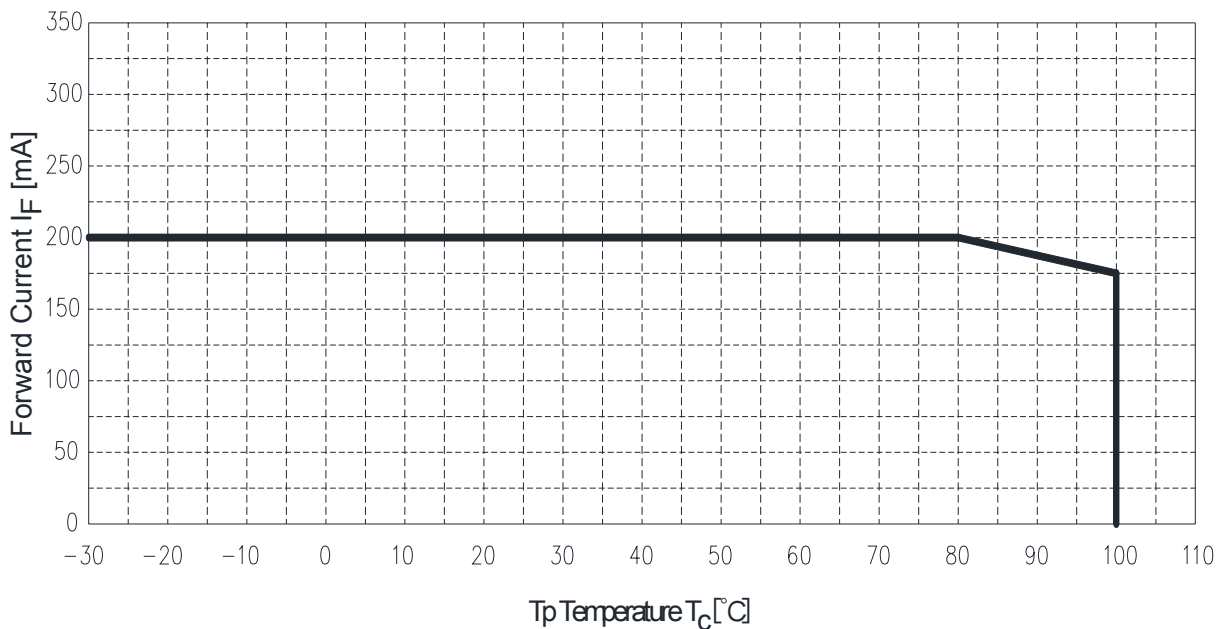

To keep  $T_p$ (PAD-temperature) lower than rating enough heat-radiation performance needs to be secured by using an adequate heat sink.

## Typical Polar Radiation Pattern

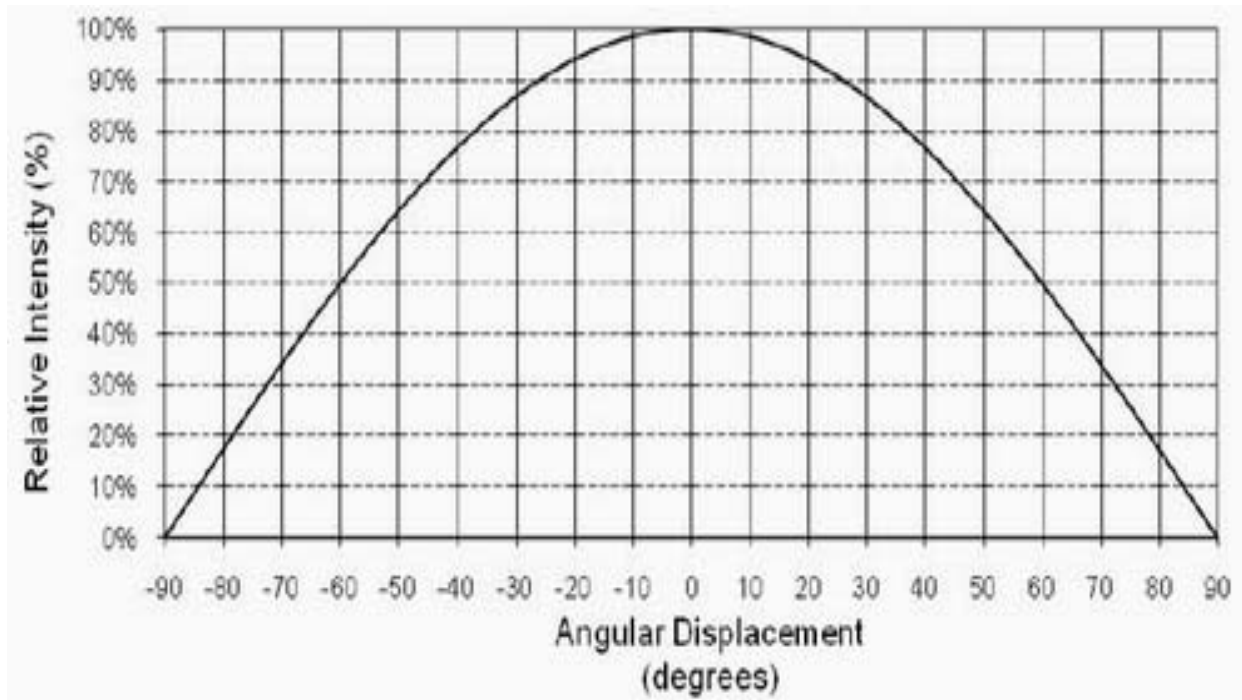

## Typical Spatial Radiation Pattern

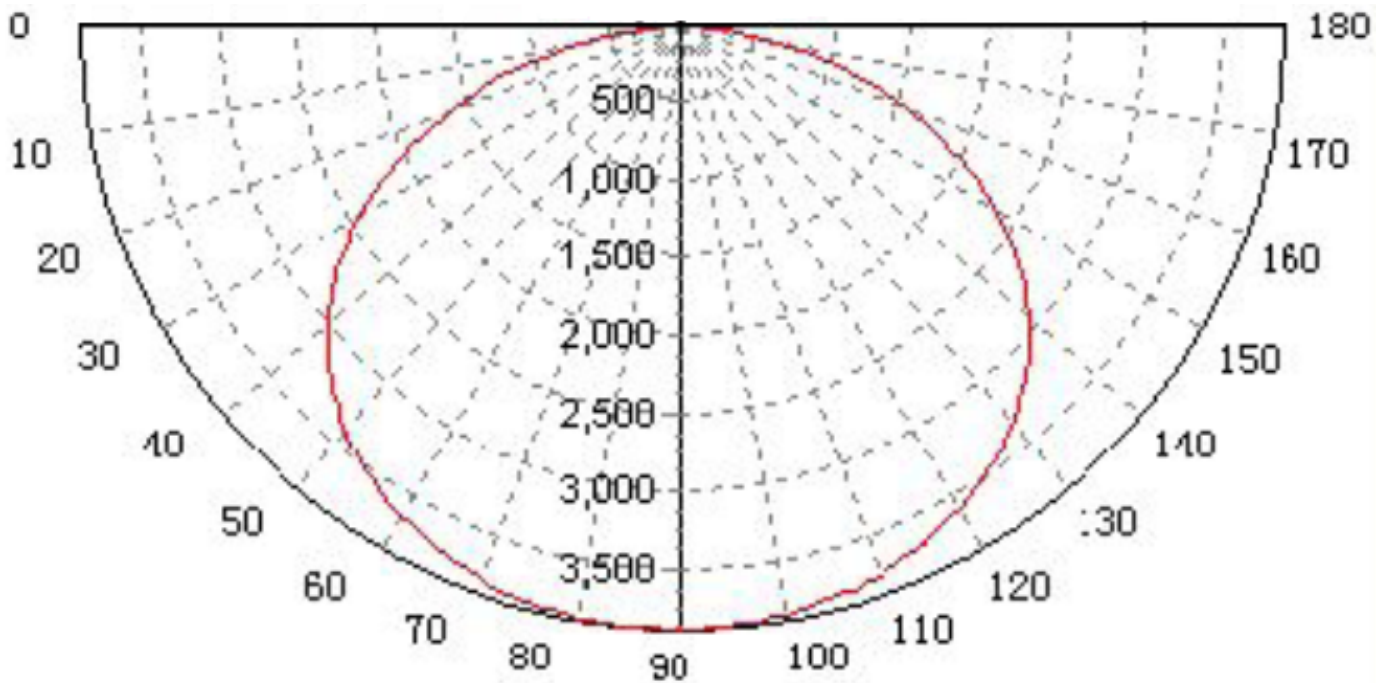

## Typical Polar Radiation Pattern

## Order Code

**LC OB35-10W0 30 XX E R80 0400**  
X1            X2                    X3            X4    X5    X6    X7            X8

### Part Number System:

X1: "LC" Abbr."Lightspot Ceramic COB"

X2: COB LED Outline Size: 4008、4012、6012; OB25、OB35、OB50

X3: Power. 10W0 repents 10Watt

X4: Color temperature: 27、30、35、40、45、50、57、65...

X5: Chip specification

X6: Lumen range, 如:  $70\text{lm/w} \leq E < 90\text{lm/w}$ ;  $90\text{lm/w} \leq F < 110\text{lm/w}$ ;

$110\text{lm/w} \leq G < 130\text{lm/w}$

X7: Color rendering Index(CRI):  $55 \leq R55 < 60$ ;  $60 \leq R60 < 65$ ;  $65 \leq R65 < 70$ ;  $70 \leq R70 < 75$

$75 \leq R75 < 80$ ;  $80 \leq R80 < 85$ ;  $85 \leq R85 < 90$ ;  $90 \leq R90 < 95$

H: Standard Forward Current. 0400 repents 400mA

### NOTICE:

- All dimensions are in millimeter.
- Tolerance is  $\pm 0.1\text{mm}$  unless otherwise noted.
- It is strongly recommended that the temperature of lead be not higher than  $60^{\circ}\text{C}$ .
- This information in this document is subject to change in order to improve reliability, design or function without prior notice and does not represent a commitment on the part of this company.
- Avoids preserving in the high temperature, the high-moisture, as well as in the acidic environment .